



Away from the Desk

A dynamic & extensive
upholstery system

orangebox



Product Description

Away from the Desk (AftD) is a soft upholstery system designed to answer the rapidly changing needs of the workplace as we migrate away from personal desks with their fixed and tethered technology towards shared, collaborative spaces and furniture.

AftD answers the need for more diverse configurations for both personal work and teamwork. Multiple specification options – for individual use, or for two, four or six people – can be further configured with larger, more open and more inclusive collaborative working configurations at lounge, table or café height.

AftD's high back design provides refined acoustic and visual privacy, and offers an upright, ergonomically controlled seating position more reflective of a task seat posture. It also provides multiple specification options for large and small work surfaces, and can meet a wide variety of power, data and monitor requirements.







With the help of our clients, their designers and specifiers, AftD is helping to transform office environments and working practices. And, just as the 'Hoover' brand gave birth to the verb 'to Hoover' (though we wouldn't dare to go as far as comparing their stories!), AftD has become an industry archetype, used as a verb to describe being able to work increasingly away from the desk.









Top – AftD Group, **Bottom** – AftD Group

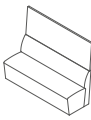
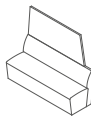
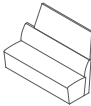

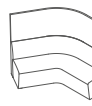
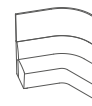

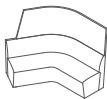
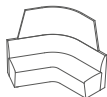

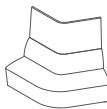
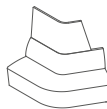

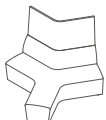

Product Range

AD-01 800mm straight seat	AD-02 800mm straight seat & back	AD-03 800mm straight seat, back & screen	AD-03 LC 800mm straight seat, back & left hand chamfered screen	AD-03 RC 800mm straight seat back & right hand chamfered screen	AD-11 1800mm straight seat	AD-12 1800mm straight seat & back
						
H470 [H22] SH480 [SH19] W800 [W31] D510 [D20] SD500 [SD20]	H820 [H32] SH480 [SH19] W800 [W31] D660 [D26] SD500 [SD20]	H1470 [H58] SH480 [SH19] W800 [W31] D710 [D28] SD500 [SD20]	H1470 [H58] SH480 [SH19] W800 [W31] D710 [D28] SD500 [SD20]	H1470 [H58] SH480 [SH19] W800 [W31] D710 [D28] SD500 [SD20]	H470 [H19] SH480 [SH19] W1800 [W71] D510 [D20] SD500 [SD20]	H820 [H32] SH480 [SH19] W1800 [W71] D660 [D26] SD500 [SD20]

AD-13 1800mm straight seat, back & screen	AD-13 LC 1800mm straight seat, back & left hand chamfered screen	AD-13 RC 1800mm straight seat, back & right hand chamfered screen	AD-21 120° seat	AD-22 120° seat & external back	AD-23 120° seat, external back & screen	AD-23 LC 120° seat, external back & left hand chamfered screen
						
H1470 [H58] SH480 [SH19] W1800 [W71] D710 [D28] SD500 [SD20]	H1470 [H58] SH480 [SH19] W1800 [W71] D710 [D28] SD500 [SD20]	H1470 [H58] SH480 [SH19] W1800 [W71] D710 [D28] SD500 [SD20]	H470 [H22] SH480 [SH19] W1985 [W78] D910 [D36] SD500 [SD20]	H820 [H32] SH480 [SH19] W2130 [W84] D1060 [D42] SD500 [SD20]	H1470 [H58] SH480 [SH19] W2185 [W86] D1110 [D44] SD500 [SD20]	H1470 [H58] SH480 [SH19] W2160 [W85] D1110 [D44] SD500 [SD20]

AD-23 RC 120° seat, external back & right hand chamfered screen	AD-23 DC 120° seat, external back & double chamfered screen	AD-24 120° seat & internal back	AD-25 120° seat, internal back & screen	AD-25 LC 120° seat, internal back & left hand chamfered screen	AD-25 RC 120° seat, internal back & right hand chamfered screen	AD-25 DC 120° seat, internal back & double chamfered screen
						
H1470 [H58] SH480 [SH19] W2160 [W85] D1110 [D44] SD500 [SD20]	H1470 [H58] SH480 [SH19] W2130 [W84] D1110 [D44] SD500 [SD20]	H820 [H32] SH480 [SH19] W1985 [W78] D1045 [D41] SD500 [SD20]	H1470 [H58] SH480 [SH19] W1985 [W78] D1090 [D43] SD500 [SD20]	H1470 [H58] SH480 [SH19] W1985 [W78] D1090 [D43] SD500 [SD20]	H1470 [H58] SH480 [SH19] W1985 [W78] D1090 [D43] SD500 [SD20]	H1470 [H58] SH480 [SH19] W1985 [W78] D1090 [D43] SD500 [SD20]

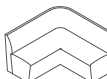
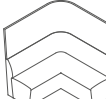
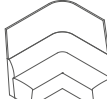
AD-31 120° tri seat	AD-32 120° tri seat & internal back	AD-33 120° tri seat, internal back & screen	AD-33 LC 120° tri seat, internal back & left hand chamfered screen	AD-33 RC 120° tri seat, internal back & right hand chamfered screen	AD-33 DC 120° tri seat, internal back & double chamfered screen	AD-41 90° seat
						
H470 [H19] SH480 [SH19] W1985 [W78] D1720 [D68] SD500 [SD20]	H820 [H32] SH480 [SH19] W1985 [W78] D1850 [D73] SD500 [SD20]	H1470 [H58] SH480 [SH19] W1985 [W78] D1890 [D74] SD500 [SD20]	H1470 [H58] SH480 [SH19] W1985 [W78] D1890 [D74] SD500 [SD20]	H1470 [H58] SH480 [SH19] W1985 [W78] D1890 [D74] SD500 [SD20]	H1470 [H58] SH480 [SH19] W1985 [W78] D1850 [D73] SD500 [SD20]	H470 [H19] SH480 [SH19] W1295 [W51] D1295 [D51] SD500 [SD20]

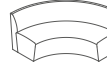
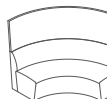
AD-42 90° seat & back	AD-43 90° seat, back & screen	AD-43 LC 90° seat, back & left hand chamfered screen	AD-43 RC 90° seat, back & right hand chamfered screen	AD-43 DC 90° seat, back & double chamfered screen	AD-52 90° curved seat & back	AD-53 90° curved seat, back & screen
						
H820 [H32] SH480 [SH19] W1445 [W57] D1445 [D57] SD500 [SD20]	H1470 [H58] SH480 [SH19] W1495 [W59] D1495 [D59] SD500 [SD20]	H1470 [H58] SH480 [SH19] W1495 [W59] D1495 [D59] SD500 [SD20]	H1470 [H58] SH480 [SH19] W1495 [W59] D1495 [D59] SD500 [SD20]	H1470 [H58] SH480 [SH19] W1495 [W59] D1495 [D59] SD500 [SD20]	H820 [H32] SH480 [SH19] W1835 [W72] D850 [D33] SD500 [SD20]	H1470 [H58] SH480 [SH19] W1900 [W75] D900 [D35] SD500 [SD20]

mm["]

SH - Seat Height — SD - Seat Depth

Product Range

AD-53 LC

90° curved seat, back & left hand chamfered screen

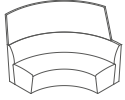

H1470 [H58] SH480 [SH19]
W1865 [W73]
D900 [D35] SD500 [SD20]

AD-53 RC

90° curved seat, back & right hand chamfered screen

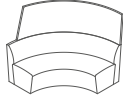

H1470 [H58] SH480 [SH19]
W1865 [W73]
D900 [D35] SD500 [SD20]

AD-53 DC

90° curved seat, back & double chamfered screen

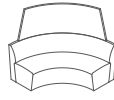

H1470 [H58] SH480 [SH19]
W1835 [W72]
D900 [D35] SD500 [SD20]

AD-55

90° small curved seat & back

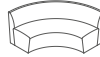

H820 [H32] SH480 [SH19]
W1635 [W64]
D805 [D32] SD500 [SD20]

AD-56

90° small curved seat, back & screen

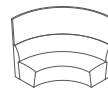

H1470 [H58] SH480 [SH19]
W1710 [W67]
D855 [D34] SD500 [SD20]

AD-56 LC

90° small curved seat, back & left hand chamfered screen

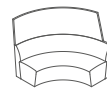

H1470 [H58] SH480 [SH19]
W1670 [W66]
D855 [D34] SD500 [SD20]

AD-56 RC

90° small curved seat, back & right hand chamfered screen

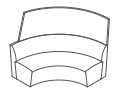

H1470 [H58] SH480 [SH19]
W1670 [W66]
D855 [D34] SD500 [SD20]

AD-56 DC

90° small curved seat, back & double chamfered screen



H1470 [H58] SH480 [SH19]
W1635 [W64]
D855 [D34] SD500 [SD20]

AD-57 LH

Small left hand spur

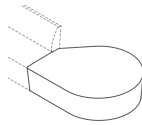

H470 [H19]
W1340 [W53]
D1600 [D63]

AD-57 RH

Small right hand spur

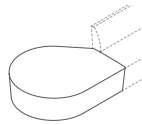

H470 [H19]
W1340 [W53]
D1600 [D63]

AD-58 LH

Large left hand spur

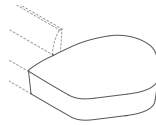

H470 [H19]
W1430 [W56]
D1600 [D63]

AD-58 RH

Large right hand spur

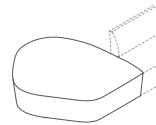

H470 [H19]
W1430 [W56]
D1600 [D63]

AD-59 LH

Left hand spur arm

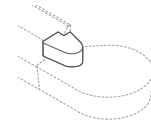

H220 [H9]
W540 [W21]
D440 [D17]

AD-59 RH

Right hand spur arm

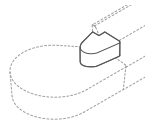

H220 [H9]
W540 [W21]
D440 [D17]

AD-61 LA

Upholstered left hand arm

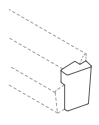

H700 [H28]
W275 [W11]
D460 [D18]

AD-61 RA

Upholstered right hand arm

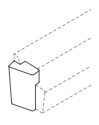

H700 [H28]
W275 [W11]
D460 [D18]

AD-62 LC

Upholstered left hand arm with side table

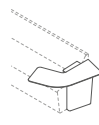

H725 [H29]
W780 [W31]
D1025 [D40]

AD-62 RC

Upholstered right hand arm with side table

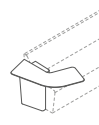

H725 [H29]
W780 [W31]
D1025 [D40]

AD-63 LP

LH presentation top with upholstered base

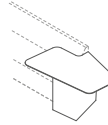

H725 [H29]
W900 [W35]
D1335 [D53]

AD-63 RP

RH presentation top with upholstered base

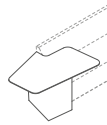

H725 [H29]
W900 [W35]
D1335 [D53]

AD-64 SRO

Large upholstered, tapered base with small round top

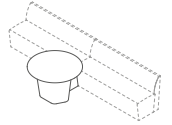

H730 [H29]
W1100 [W43]
D1100 [D43]

AD-64 MRO

Large upholstered, tapered base with medium round top

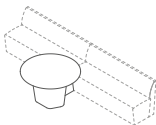

H730 [H29]
W1200 [W47]
D1200 [D47]

AD-64 LRO

Large upholstered, tapered base with large round top

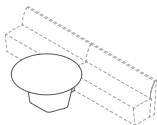

H730 [H29]
W1400 [W55]
D1400 [D55]

AD-64 SW

Large upholstered, tapered base with small winged top

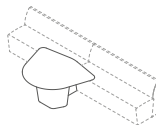

H730 [H29]
W1450 [W57]
D1200 [D47]

AD-64 LW

Large upholstered, tapered base with large winged top

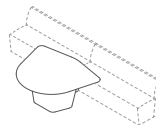

H730 [H29]
W1655 [W65]
D1400 [D55]

AD-64 120

Large upholstered, tapered base with 120° top

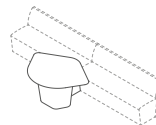

H730 [H29]
W1465 [W58]
D1135 [D45]

AD-64 HE

Extra large upholstered, tapered base with hex top

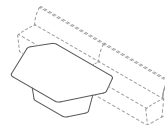

H730 [H29]
W2170 [W85]
D1400 [D55]

AD-67 RE

Integrated banquette base with rectangular top

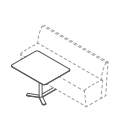

H730 [H29]
W950 [W37]
D750 [D30]

AD-67 SQ

Integrated banquette base with square top

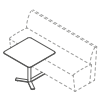

H730 [H29]
W750 [W30]
D750 [D30]

AD-71

Upholstered square corner table with cam top

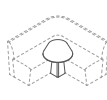

H730 [H29]
W600 [W24]
D790 [D31]

AD-72

Upholstered oval base with rounded top

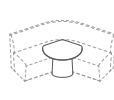

H730 [H29]
W800 [W31]
D700 [D28]

AD-81 DS

Low media unit with D - shaped top table height - 730mm



H1455 [H57]
W1300 [W51]
D1350 [D53]

AD-81 OV

Low media unit with group top [oval] table height - 730mm

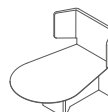

H1455 [H57]
W1300 [W51]
D1850 [D73]

AD-81 GR

Low media unit with group top [rounded] table height - 730mm

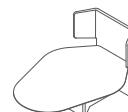

H1455 [H57]
W1320 [W52]
D1850 [D73]

AD-81 GT

Low media unit with group top [tapered] table height - 730mm

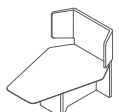

H1455 [H57]
W1310 [W52]
D1850 [D73]

mm["]

SH - Seat Height — SD - Seat Depth

Product Range

AD-81 HE120

Low media unit with hex top
table height - 730mm

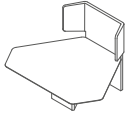

H1455 [H57]
W2170 [W85]
D1650 [D65]

AD-81 HE90

Low media unit with hex top
table height - 730mm

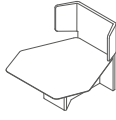

H1455 [H57]
W1675 [W66]
D1650 [D65]

AD-82 DS

High media unit with D-shaped top
table height - 1050mm



H1775 [H70]
W1300 [W51]
D1350 [D53]

AD-82 OV

High media unit with group top (oval)
table height - 1050mm



H1775 [H70]
W1300 [W51]
D1850 [D73]

AD-85

Enclosed media den (seats 6-8 people)
table height - 730mm

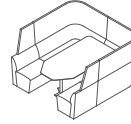

H1470 [H58] SH480 [SH19]
W2350 [W93]
D2295 [D90] SD500 [SD20]

AD-85 A

Enclosed media den (seats 4-6 people)
table height - 730mm

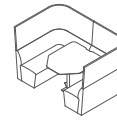

H1470 [H58] SH480 [SH19]
W2350 [W93]
D1495 [D59] SD500 [SD20]

AD-85 B

Enclosed media den (seats 2 people)
table height - 730mm

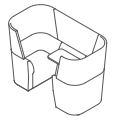

H1470 [H58] SH480 [SH19]
W2130 [W84]
D1140 [D45] SD500 [SD20]

AD-85 C

Enclosed media booth (seats 4-6 people)
table height - 730mm

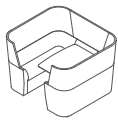

H1470 [H58] SH480 [SH19]
W2130 [W84]
D1945 [D77] SD500 [SD20]

AD-85 D

Enclosed media booth (seats 6-8 people)
table height - 730mm

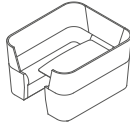

H1470 [H58] SH480 [SH19]
W2130 [W84]
D2440 [D96] SD500 [SD20]

AD-86 LH

Left handed work station with table
table height - 730mm



H1470 [H58] SH480 [SH19]
W1580 [W62]
D1955 [D77] SD500 [SD20]

AD-86 RH

Right handed work station with table
table height - 730mm



H1470 [H58] SH480 [SH19]
W1580 [W62]
D1955 [D77] SD500 [SD20]

AD-87 C

Curved seating configuration with table
table height - 730mm

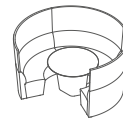

H1470 [H58] SH480 [SH19]
W2700 [W106]
D2300 [D91] SD500 [SD20]

AD-87 S

Square seating configuration

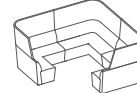

H1470 [H58] SH480 [SH19]
W2990 [W114]
D2990 [D114] SD500 [SD20]

AD-88 C1

Seating Configuration 1-90° units

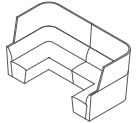

H1470 [H58] SH480 [SH19]
W2990 [W118]
D1495 [D59] SD500 [SD20]

AD-88 C2

Seating Configuration 2-120° units

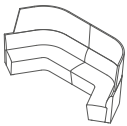

H1470 [H58] SH480 [SH19]
W3700 [W146]
D1450 [D57] SD500 [SD20]

AD-88 C3

Seating Configuration 3-90° units & 120° units

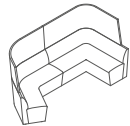

H1470 [H58] SH480 [SH19]
W3300 [W130]
D1495 [D59] SD500 [SD20]

AD-88 C4

Seating Configuration 4-90° units & 120° units

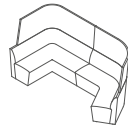

H1470 [H58] SH480 [SH19]
W3300 [W130]
D1495 [D59] SD500 [SD20]

AD-91 SRO

Huddle buddle group working table 1200 diameter top



H730 [H29]
W1200 [W47]
D1200 [D47]

AD-91 LRO

Huddle buddle group working table 1400 diameter top



H730 [H29]
W1400 [W55]
D1400 [D55]

AD-92

600mm diameter working table low table



H500 [H20]
W600 [W24]
D600 [D24]

AD-101

Single seat unit



H820 [H32] SH480 [SH19]
W1035 [W41]
D660 [D26] SD500 [SD20]

AD-102

Single seat unit & screen



H1470 [H58] SH480 [SH19]
W1140 [W45]
D710 [D28] SD500 [SD20]

AD-101 LT

Single seat unit with left handed integrated tablet



H820 [H32] SH480 [SH19]
W1035 [W41]
D915 [D36] SD500 [SD20]

AD-101 RT

Single seat unit with right handed integrated tablet



H820 [H32] SH480 [SH19]
W1035 [W41]
D915 [D36] SD500 [SD20]

AD-102 LT

Single seat unit, screen with left handed integrated tablet

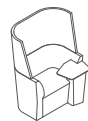

H1470 [H58] SH480 [SH19]
W1140 [W45]
D965 [D38] SD500 [SD20]

AD-102 RT

Single seat unit, screen with right handed integrated tablet



H1470 [H58] SH480 [SH19]
W1140 [W45]
D965 [D38] SD500 [SD20]

AD-103

Three seater unit

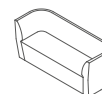

H820 [H32] SH480 [SH19]
W835 [W33]
D660 [D26] SD500 [SD20]

AD-104

Three seater unit & screen



H1470 [H58] SH480 [SH19]
W1940 [W76]
D710 [D28] SD500 [SD20]

AD-103 LT

Three seater unit with left handed integrated tablet

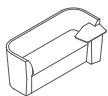

H820 [H32] SH480 [SH19]
W1835 [W72]
D915 [D36] SD500 [SD20]

AD-103 RT

Three seater unit with right handed integrated tablet

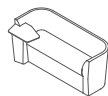

H820 [H32] SH480 [SH19]
W1835 [W72]
D915 [D36] SD500 [SD20]

AD-104 LT

Three seater unit, screen with LH integrated tablet



H1470 [H58] SH480 [SH19]
W1940 [W76]
D965 [D38] SD500 [SD20]

AD-104 RT

Three seater unit, screen with RH integrated tablet



H1470 [H58] SH480 [SH19]
W1940 [W76]
D965 [D38] SD500 [SD20]

mm["]

SH - Seat Height — SD - Seat Depth



Image London Smartworking – AftD Configuration

Product Specification

Standard Product Description

Frame: FSC® Plywood & FSC® Hardwood frame with glued & screwed units.

Seat & Back: Elasticated sprung seat & foam back.

Foam: Vitafoam Reflex.

Glides: Adjustable & linkable glides with non-marking elastomer foot.

Banquette Table Column and Foot: Finished in Industrial Silver, Black or White.

Table Top Finishes:

Melamine – Walnut, Grained Oak, Artisan Oak, Beech, Graphite, White or Grey.

N.B Straight units (800mm and 1800mm) with screens cannot be specified free-standing and should only be used within a configuration.

Optional Upcharges

Power: Base or Arm power options available.

Monitor: Tilting Monitor Brackets available as an upcharge on Media Den Units.

Banquette Table Column and Foot: Black Foot and Chrome Column available as an upcharge. Or Foot and Column finished in Gold, Taupe, Bronze or Copper.

Product Certification

Intertek Sustainability Clean Air Product Certification

Clean Air certification provides proof that products have been independently tested and found to conform to VOC standards and to the ANSI/ BIFMA Furniture Emissions Standards. All Orangebox products* have achieved Gold certification, excluding laminate products which achieve a Silver certification.

*With the exception of Fielding Tables.

BS 16139: 2013

Test Level 1 - Strength & Safety.

Fabric Selection

Modular Units

Modular seating units have up to 4 upholstery choices.

These choices are stated in the diagram opposite.

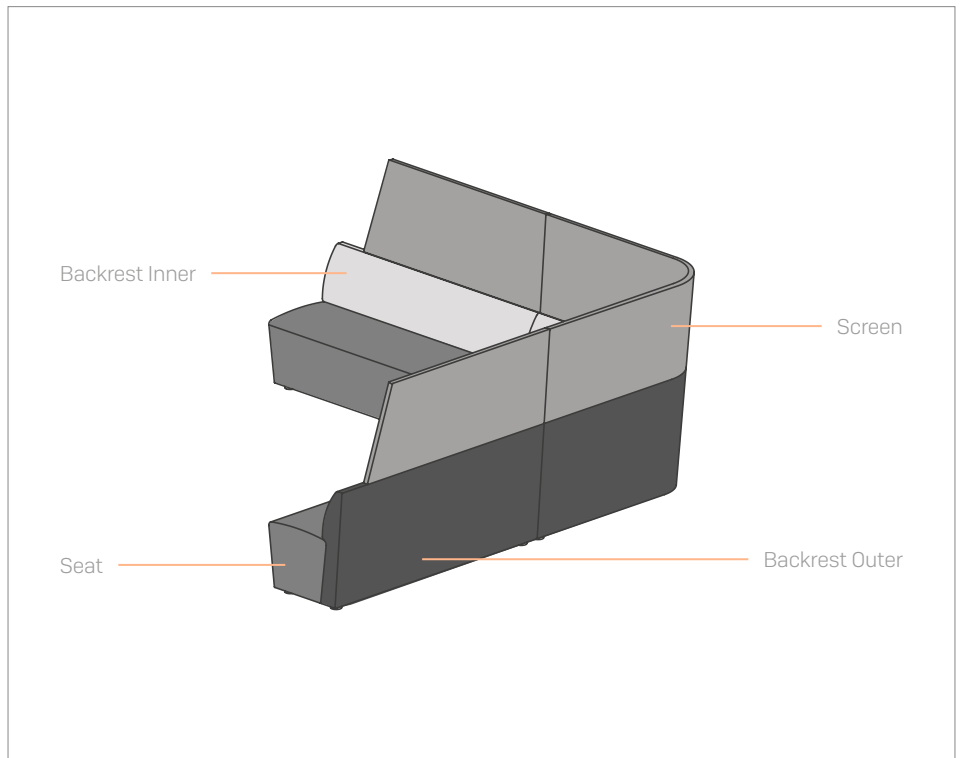

Detached Seating

As with the modular units above, the main body of the detached seating is split into 5 upholstery choices.

Some stand alone seating units have the addition of an integrated tablet base as a separate upholstery choice.

Tablet support and arms must be a plain fabric. Inner, outer screen must be a plain fabric from the same fabric range.

Inner, lower back or seat can be a pattern fabric, but a different range.

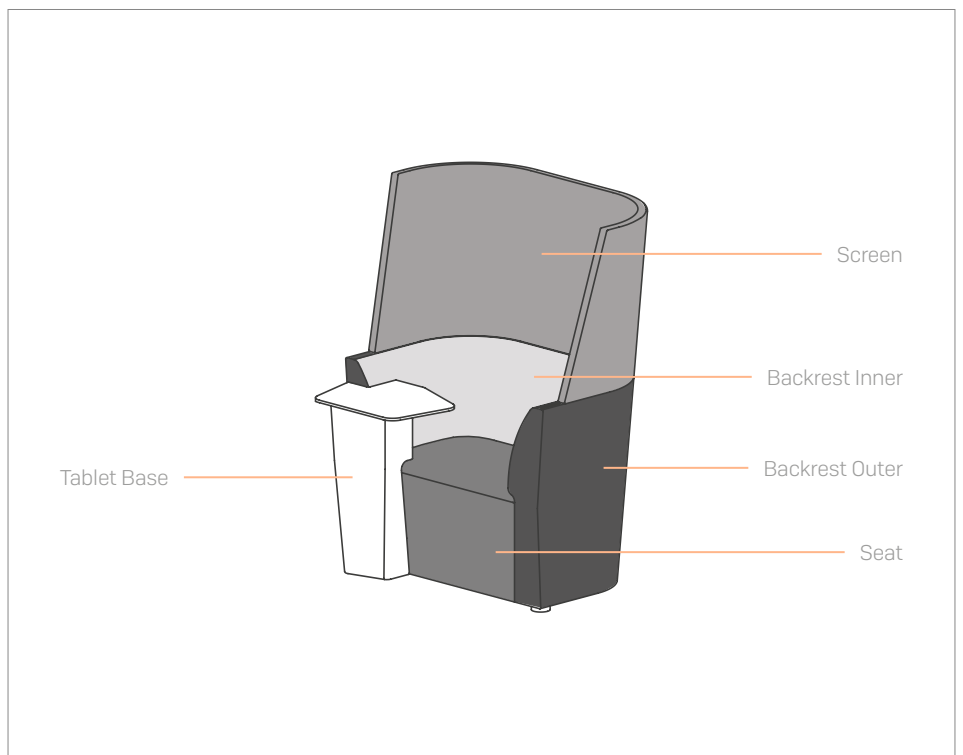

Fabric Selection

Striped, patterned or plaid fabrics are only available for specification on the seat or backrest inner portions as illustrated below.

When selecting pattern fabrics for Away from the Desk, panels will be cut by hand. Inner and outer, and high back screen must be selected from the same fabric range.

Horizontal Stripes

These stripes are governed by the way the fabrics come off the roll. If it comes off vertical then the stripes must be horizontal.

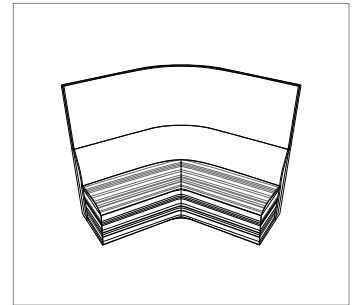
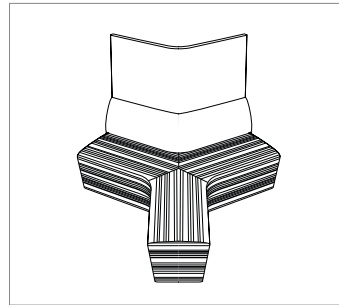
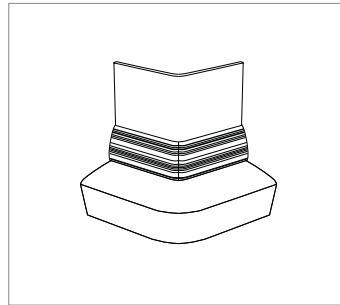
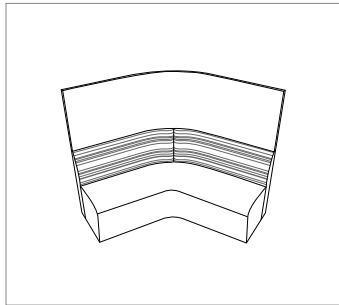

Vertical Stripes

These stripes are governed by the way the fabrics come off the roll. If it comes off horizontal then the stripes must be vertical.

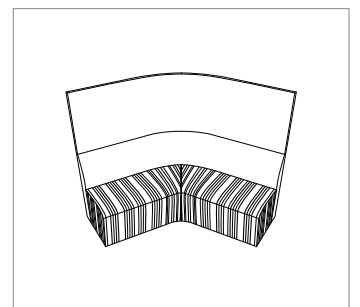
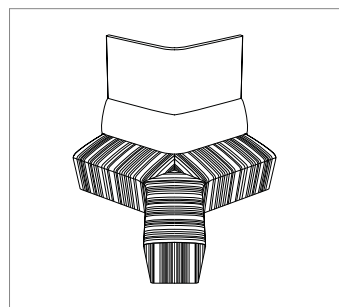
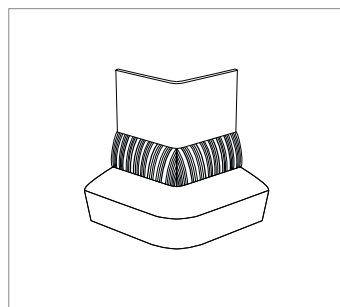
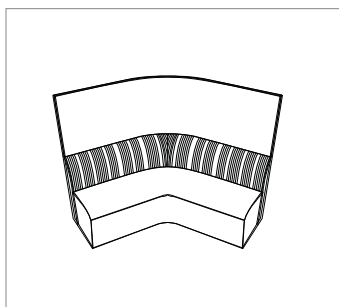

Product Finishes

Table Tops — Melamine

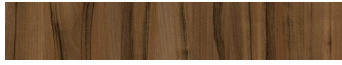

Walnut



Grained Oak



Artisan Oak



Beech



Graphite



Grey



White

Banquette Table Column & Foot



Black



White



Chrome



Gold



Taupe

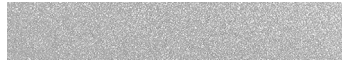

Industrial Silver



Bronze



Copper